

positilt[®]

PTK-CANOP, PTK-SAE J1939

Gyro-compensated Inclination Sensors

Installation and operation manual

EN

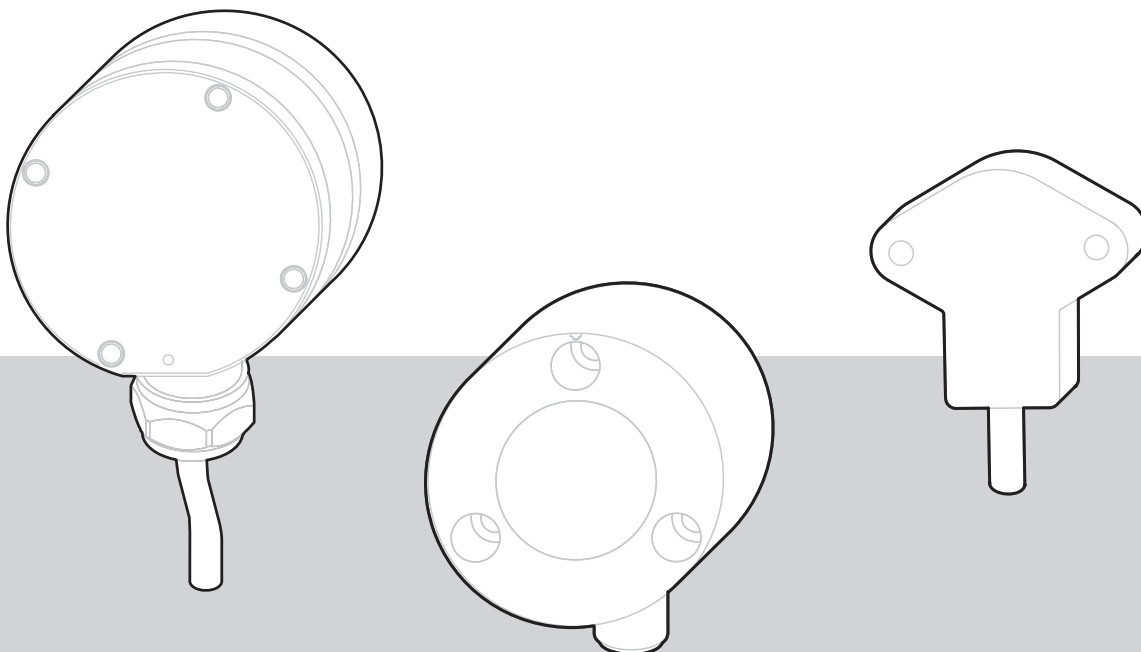

Please read carefully before installation and operation!

© ASM Automation Sensorik Messtechnik GmbH, 2019
All rights reserved.

Am Bleichbach 18 - 24
85452 Moosinning
Germany

1 Safety instructions	4
1.1 Signal words and symbols	4
1.2 General safety instructions.....	4
1.3 Intended use.....	5
2 Transport and storage.....	5
3 Installation and initial operation.....	6
3.1 Mechanical installation	6
3.2 Electrical connection	8
3.3 Operating temperature	9
3.4 Characteristic of the linear output and mounting options.....	10
4 Maintenance and disposal	14
4.1 Maintenance and disposal	14
4.2 Disposal.....	14
5 Output specification.....	15
5.1 Digital output CANopen.....	15
5.2 Digital output SAE J1939	17

1 Safety instructions

1.1 Signal words and symbols



WARNING, Risk of Injury:

Indicates a potentially hazardous situation, which, if not avoided, can result in serious injury or property damage.

▲ DANGER

WARNING, Risk of Personal Injury or Death:

Indicates a situation that can result in serious personal injury or death if not properly avoided.

▲ WARNING

WARNING, Risk of Personal Injury or Death:

Indicates a situation that can result in moderate personal injury or death if not properly avoided.

▲ CAUTION

WARNING, Risk of Personal Injury:

Indicates a situation that can result in minor personal injury if not properly avoided.

NOTICE

WARNING, Risk of Property Damage:

Indicates a situation that can result in minor to major property damage if not properly avoided.

Product liability

- Disregarding the following instructions may result in malfunction, damage to property and personal injury and releases the manufacturer from product liability.

Safety regulations

- National safety regulations must be observed!

1.2 General safety instructions

▲ WARNING

Danger of injury to the operator or damage to the property

- Connection to power supply must be performed in accordance with safety instructions for electrical facilities and performed only by qualified personnel.
- Any alteration, reconstruction or extension of the sensor is not allowed!
- The sensor must be operated only within values specified in the catalog or datasheet.
- The danger of personal injury and danger of property damage due to a malfunction of the sensor in machines or systems must be excluded by additional safety measures.
- In safety-relevant applications, additional facilities must be provided for maintaining safety and preventing damage.
- Check whether the protection class of the sensor is suitable for the application.

NOTICE

Mechanical damage or destruction of the sensor

- Do not open the sensor.
- Avoid impact and shock to the sensor.

1.3 Intended use

positilt® inclination sensors of PTK series measure inclination between $\pm 15^\circ$ and $\pm 180^\circ$ utilizing gyro-compensated MEMS technology. The angular position is converted into a standardized output. For determining measuring range, environmental compatibility and connection data of the sensor, please note the data sheet. Use the sensor as intended by operating within its specified technical data and ambient conditions.

The installation and operating instructions supplied with the unit must be respected. All maintenance and service work must be carried out. The data sheet of the respective sensor is part of this instruction manual. If not yet available, it may be requested by stating the respective model number.

The sensor must not be improperly mounted, operated or serviced. In addition, operation of the sensor in faulty condition is prohibited.

2 Transport and storage

Observe storage and transport temperatures according to the temperatures specified in the data sheet. Max. rel. humidity 60%, dew condensation must be prevented at all times. The device must be secured against slipping and tipping during transport.

Shipment damage

Check sensor immediately for shipment damage. In case of any damage or equipment not operating appropriately, please contact your supplier.

Shipment content

- Sensor
- Installation and operation manual

3 Installation and initial operation

3.1 Mechanical installation

Inclination Sensor PTK4

NOTICE
Risk of damage to the sensor due to corrosion

- Mount the sensor on a flat surface
- Avoid or seal gaps of <0.5mm while mounting the sensor
- Use seawater-proof material
- Take suitable precautions against fouling
- Remove the infestation in case of fouling
- Define suitable maintenance intervals

Mounting method	Material	Torque [Nm]
M6 screws	A4	<4

Installation of the sensor supply cable (underwater housing)

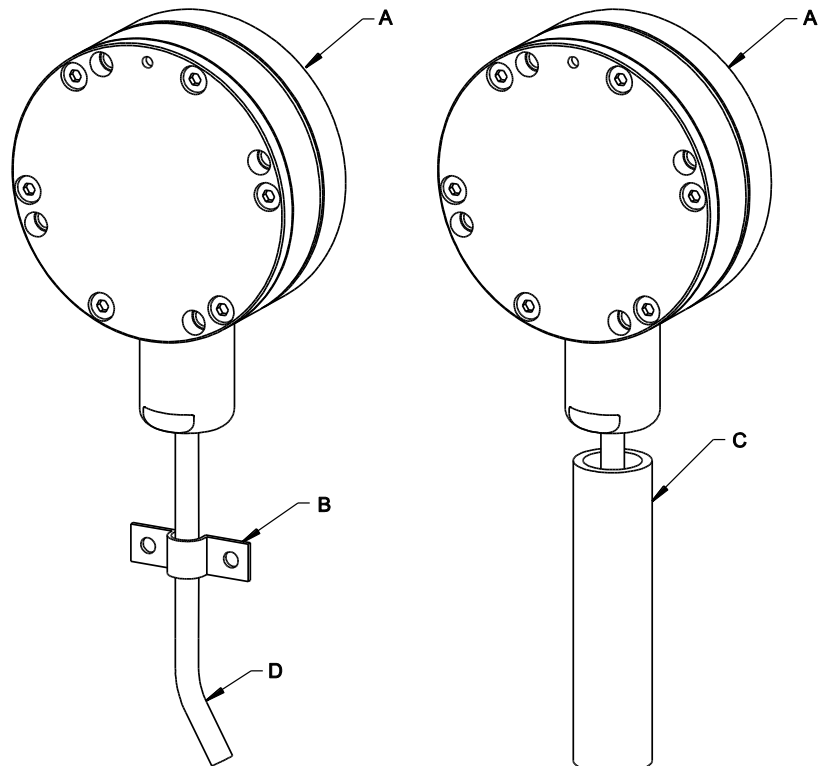

A – PTK4

B – Strain relief with a separate cord grip

C – Mechanical protection

D – R>30 min. bending radius with fixed cable
R>30 min. bending radius with free cable

Lateral inclination sensitivity:





Up to 30° lateral inclination the resulting error is $\leq 1^\circ$.

Torque for fixing screws

- The specified torques and mounting methods are general recommendations and can differ according to application and operating conditions.

Mounting method	Material	Torque [Nm]
Screws M4 (PTK29, PTM29)	–	1
Screws M6 (PTK4)	A2	<6
Screws M8	–	<10

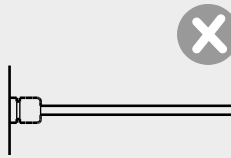
Installation of the sensor supply cable

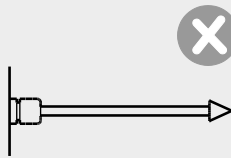
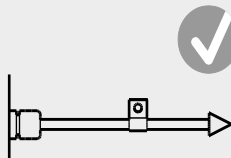
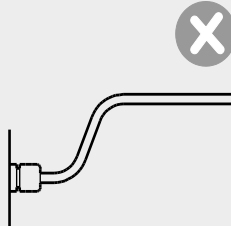
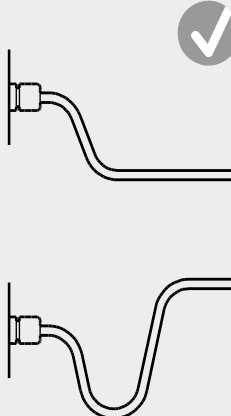
	incorrect	correct
<p>Admissible bending radius of the cable must be observed: $R \sim 5 \times D$ $R \sim 10 \times D$ (underwater cable)</p>		
<p>Length compensation for the cable must be observed</p>		
<p>A separate cord grip for cable strain relief is recommended</p>		
<p>Observe cable routing in case of splashing water, water condensation and humidity</p>		

3.2 Electrical connection

NOTICE**Damage or destruction of the sensor due to excessive operating voltage or mounting error**

- The applied operating voltage must not exceed the value specified in the data sheet.
- Operate the sensor only within the limits specified in the data sheet.
- Connecting to the power supply only by qualified personnel and in accordance with the applicable safety regulations for electrical equipment.
- Do not connect or disconnect the sensor under voltage!

Corrosion in the sensor due to moisture penetration

- Use the sensor only according to protection class.
- The mating connector should have the same protection class as the sensor, otherwise the lower protection class of the mating connector is valid.
- Avoid crossing the dew point.
- Cable outputs must be installed in such a way that no moisture can get into the cable.
- The protection class of sensors with connector output is valid only if the electrical plug is connected!

Damage of the sensor cable due to mechanical stress

- Do not twist the M12 connector inserts.
- It is important that the knurled nuts on the connectors are tightened to the correct torque for each different size of the connector:
 - M12-ASM connectors / couplings: 1.0 Nm
 - connectors / couplings of other manufacturers: according to manufacturer instruction.
- Use a torque wrench.
- Do not strain the connection cable.
- A separate strain relief is recommended.

NOTICE

PTK4: Cable must be installed safely over a pressure proof duct to the clamp box. Mounting and protecting material must be suitable for use in sea water.

Electromagnetic Compatibility (EMC)

Electromagnetic compatibility of positilt® inclination sensors is influenced by the sensor wiring.

NOTICE

Possible malfunction of the sensor when used in systems with highly interference-prone components such as frequency inverters

Recommended wiring:

- Use single shielded sensor cable with twisted pair conductors for power supply and signal output.
- Connect the cable shield to ground on one side of the control cabinet. Connect the shield connection over a large area using cable clamps before or at the cable entry into the control cabinet. When preassembled cables are delivered, the screen is not connected to the housing on the sensor side.
- Do not install sensor cables close to power conductors such as motor or contactor control cables (use separate cable ducts for signal and power cables).
- Install the cables in metal cable ducts which are connected to ground.

3.3 Operating temperature

positilt® PTK29	-40 ... +85°C
positilt® PTK4	-40 ... +85°C
positilt® PTK6	-40 ... +85°C
positilt® PTK7	-40 ... +85°C

3.4 Characteristic of the linear output and mounting options

PTK29 - Characteristic of the linear output and mounting options

Sensor position as shown equals 0°.

The measurement range will be limited to ±60° if both axes are deflected at the same time.

2 measuring axes

Mounting option 2A

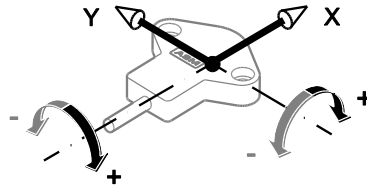

Mounting option 2B

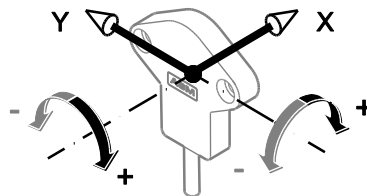

Mounting option 2C

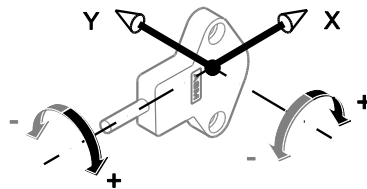

Output signal

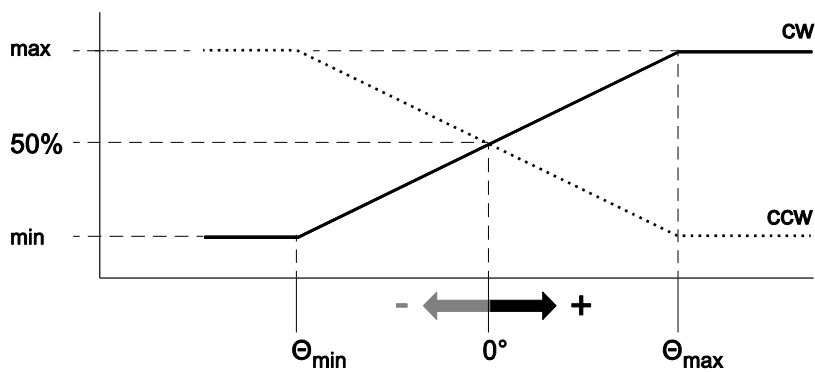

PTK4 - Characteristic of the linear output and mounting options

Sensor position as shown equals 0°.

The measurement range will be limited to ±60° if both axes are deflected in the same time.

2 measuring axes

Mounting option 2A

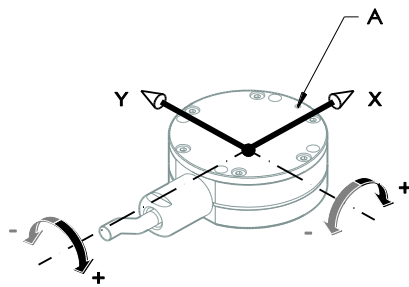

Mounting option 2B

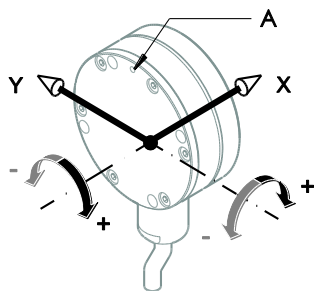

Mounting option 2C

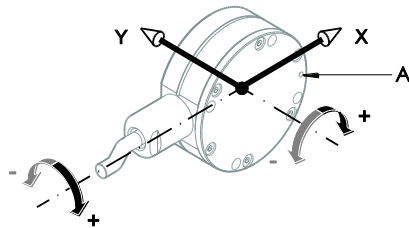

A = Marking

Output signal

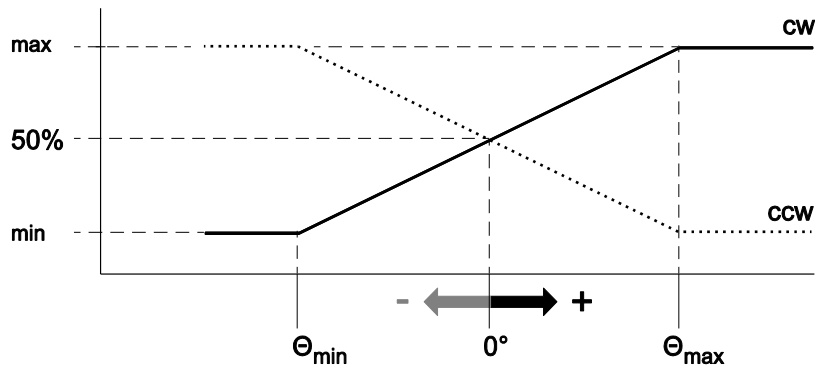

PTK6 - Characteristic of the linear output and mounting options

Sensor position as shown equals 0°.

The measurement range will be limited to ±60° if both axes are deflected in the same time.

2 measuring axes

Mounting option 2A

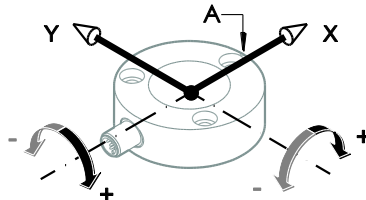

Mounting option 2B

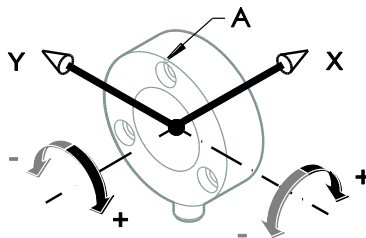

Mounting option 2C

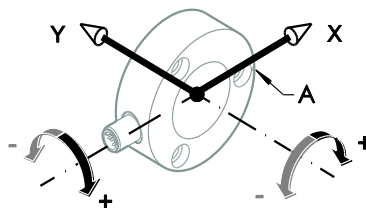

A = Marking

Output signal

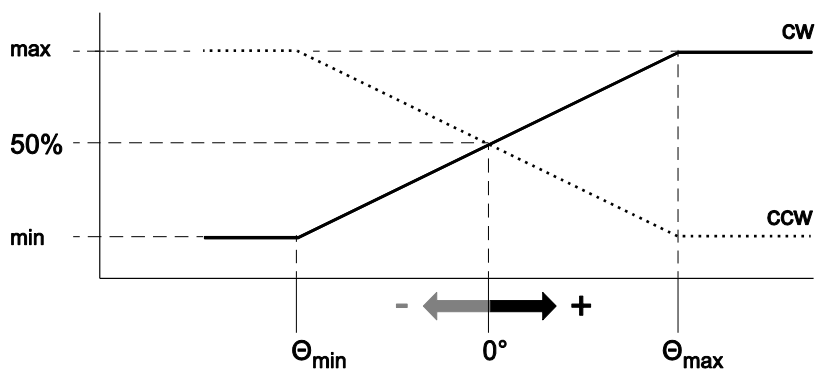

PTK7 - Characteristic of the linear output and mounting options

Sensor position as shown equals 0°.

The measurement range will be limited to ±60° if both axes are deflected in the same time.

2 measuring axes

Mounting option 2A

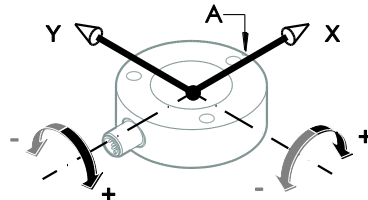

Mounting option 2B

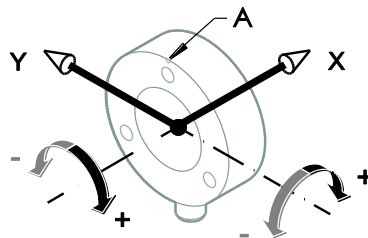

Mounting option 2C

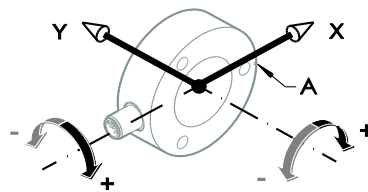

A = Marking

Output signal

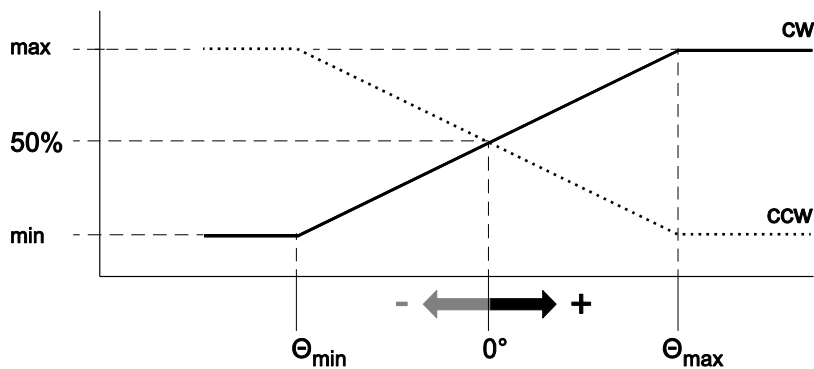

4 Maintenance and disposal

4.1 Maintenance and disposal

⚠ CAUTION

Opening all the positilt® sensors will cause damage and void the warranty

- Do not open the sensor.
- Due to possible risk of injury by improper handling, we strongly advise against repair attempts.

Check sensor regularly for possible damage:

	Integrity of housing, connector, cable	Mounting elements	Fouling check
PTK29	X	X	-
PTK4	X	X	X
PTK6	X	X	-
PTK7	X	X	-
Measures	Damaged parts: Put sensor out of service and replace damaged parts resp. send sensor to ASM for repair	Loose mounting parts: Screw tight mounting parts with recommended torque, if applicable use bolt adhesive	Remove fouling

4.2 Disposal

Disposal according to applicable government regulations.

5 Output specification

5.1 Digital output CANopen

CANOP CANopen 	Communication profile	CANopen CiA 301, Slave
	Encoder profile	CiA 410, Profile „Inclinometer“
	Configuration services	LSS, CiA Draft Standard 305 (Transmission rate, node ID)
	Error Control	Node guarding, Heartbeat, Emergency message
	Node ID	Adjustable via LSS or SDO, default: 127
	PDO	1 TxPDO, 0 RxPDO, no linking, static mapping
	PDO Modes	Event-/Time triggered, Remote-request, Sync cyclic/acyclic
	SDO	1 Server, 0 Client
	Certified	yes
	Transmission rate	125 kBit ... 1 Mbit, adjustable via LSS or SDO, default: 125 kBit
	Bus connection	M12 connector, 5 pin
	Bus, galvanic isolated	no
	Error Control Baudrate	50kBit/s ... 1MBit/s configurable
	Transceiver	24V-compliant, not isolated
	Internal termination resistor	120 Ohm configurable

Specifications	Excitation voltage	8 ... 36 V DC
	Excitation current	15 mA typical at 24 V DC 30 mA typical at 12 V DC, 100 mA max.
	Measuring rate	0.5 kHz standard
	Stability (temperature)	± 0,2° (-20 ... +40 °C) ± 0,4° (-40 ... +85 °C)
	Repeatability	1 LSB
	Operating temperature	-40 ... +85 °C
	Protection	Reverse polarity, short circuit
	EMC	DIN EN 61326-1:2013

Signal wiring	Output signals	Connector pin no.
Connector M12, 5 pin  View to the sensor connector	Shield	1
	Excitation +	2
	GND	3
	CAN-H	4
	CAN-L	5

CANopen – Set up (MCANOP)



Download

- A detailed specification of this interface can be downloaded from the ASM website:
www.asm-sensor.com/en/downloads.html > **Configuration files**

⚠ WARNING

Risk of injury by unexpected machine movement

- Change parameters only when machine is in a safe condition!
- Changing parameters may cause unexpected machine movement.
- Changing parameters may influence dependent parameters e.g. changing the resolution may have influence on position of CAM switches.
- Precautions have to be taken to avoid damage to human and machine parts!

5.2 Digital output SAE J1939

CANJ1939 SAE J1939 	CAN Specification	ISO 11898, Basic and Full CAN 2.0 B extended message format with 29-bit identifier
	Transceiver	24V-compliant, not isolated
	Communication profile	SAE J1939, 29-bit identifier
	Transmission rate	250 kBit/s
	Internal termination resistor	120 Ω
	Address	Default 247d, configurable

NAME - Unique device identifier	Name Fields	Remark	Field value	Size [Bit]	Byte order	Byte value	
	Arbitrary Address Capable	No	0	1	Byte 8 (MSB)	00h	
	Industry Group	Global	0	3			
	Vehicle System instance		0	4			
	Vehicle System	Non specific	7Fh	7	Byte 7	FEh	
	Reserved		0	1			
	Function	Non specific	FFh	8	Byte 6	FFh	
	Function Instance		0	5	Byte 5	00	
	ECU Instance		0	3			
	Manufacturer	Manufacturer Code	145h	11	Byte 4	28h	
						Byte 3	A0h+n n
		Identity Number	n..nh	21		Byte 2	nnh
							Byte 1

Proprietary PGN - Manufacturer specific Parameter Group Numbers	Configuration data	PGN EFddh	Proprietary-A (PDU1 peer-to-peer)
	Process data	PGN FFnnh	Proprietary-B (PDU2 broadcast); nn Group Extension (PS) configurable

Specifications		
	Excitation voltage	8 ... 36 V DC
	Excitation current	15 mA typical at 24 V DC 30 mA typical at 12 V DC, 100 mA max.
	Measuring rate	0.5 kHz (asynchronous)
	Stability (temperature)	$\pm 0,2^\circ$ (-20 ... +40 °C) $\pm 0,4^\circ$ (-40 ... +85 °C)
	Repeatability	1 LSB
	Operating temperature	-40 ... +85 °C
	Protection	Reverse polarity, short circuit
	EMV	DIN EN 61326-1:2013

Signal wiring	Output signals	Connector pin no.
Connector M12, 5 pin  View to the sensor connector	Shield	1
	Excitation +	2
	GND	3
	CAN-H	4
	CAN-L	5

SAE J1939 – Set up (MCANJ1939)



Download

- A detailed specification of this interface can be downloaded from the ASM website:

www.asm-sensor.com/en/downloads.html > Configuration files



Risk of injury due to unexpected machine movement

- Change parameters only when machine is in a safe condition!
- Changing parameters may cause unexpected machine movement.
- Changing parameters may influence dependent parameters e.g. changing the resolution may have influence on position of CAM switches.
- Precautions have to be taken to avoid damage to human and machine parts!

CAN-Bus wiring

Connect the device by a T-connector to the CAN trunk line. Total length of stubs should be minimized. Do not use single stub lines longer than 0.5 m. Connect terminating resistors 120 Ohm at both ends of the trunk line.

Termination resistor

T piece

CAN cable

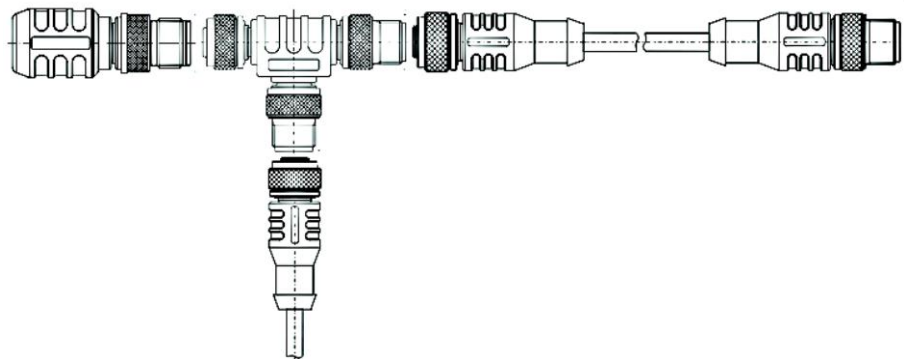

sensor

Reliability Parameters

Models	PTK-CAN	
Interfaces	CANOP	CAN interface (CANopen)
	CANJ1939	CAN interface (SAE J1939)
Reliability Parameters	Device type	B
	Life period electronics MTTFD	250 years
	Probability of failure electronics PFH (λ_{DU})	450 Fit
	Working life	20 years
	Service and calibration interval	annually
Reference conditions	Supply Voltage U_B	$U_{Bref} = 24\text{ V}$
	Reference temperature ϑ	$\vartheta_{ref} = 60^\circ\text{C}$
Standards	Failure rate of electronic components (Siemens)	SN29500







perfect in sensors.

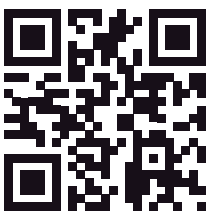

www.asm-sensor.com

**ASM Automation Sensorik
Messtechnik GmbH**
Am Bleichbach 18 - 24
85452 Moosinning
Germany
Tel. +49 8123 986-0
Fax +49 8123 986-500
info@asm-sensor.com

ASM Sensors, Inc.
650 W. Grand Ave., Unit 205
Elmhurst, IL 60126
USA
Tel. +1 630 832-3202
Fax +1 630 832-3204
info@asmsensors.com

ASM Sales Office UK
Tanyard House, High Street
Measham, Derbs DE12 7HR
United Kingdom
Tel. +44 845 1222-123
Fax +44 845 1222-124
info@asm-sensor.com