

# prodis<sup>®</sup> INC

Digital Process Meter for incremental position  
and angle sensors

---

**Installation and operation manual**

**EN**

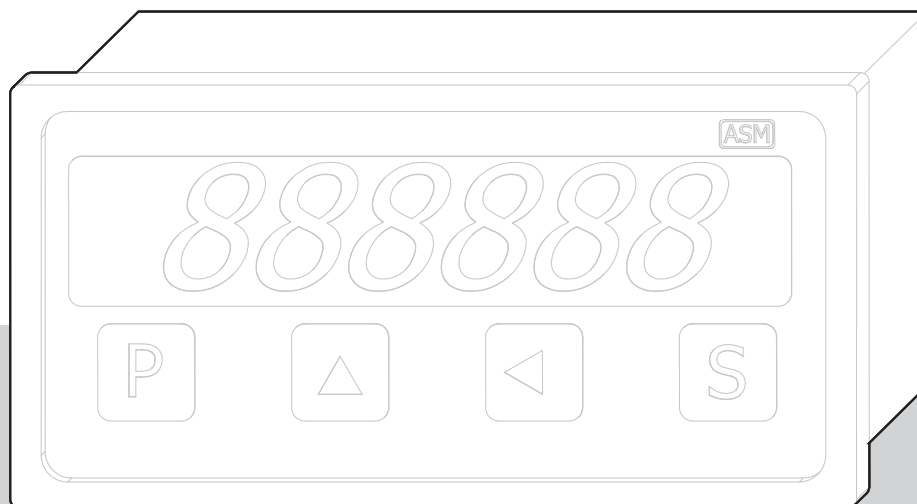

Please read carefully before installation and operation!

© ASM Automation Sensorik Messtechnik GmbH, 2019  
All rights reserved.

Am Bleichbach 18 - 24  
85452 Moosinning  
Germany

---

<b>1 Safety instructions .....</b>	<b>4</b>
1.1 Signal words and symbols .....	4
1.2 Intended use.....	5
<b>2 Transport and storage.....</b>	<b>5</b>
<b>3 Installation and initial operation.....</b>	<b>6</b>
3.1 Mechanical installation .....	6
3.2 Electrical connection .....	7
3.3 Startup.....	15
<b>4 Operation.....</b>	<b>16</b>
<b>5 Maintenance and disposal .....</b>	<b>21</b>
5.1 Maintenance and service .....	21
5.2 Disposal.....	21

# 1 Safety instructions

## 1.1 Signal words and symbols



**WARNING, Risk of Injury:**

Indicates a potentially hazardous situation, which, if not avoided, can result in serious injury or property damage.

**▲ DANGER**

**WARNING, Risk of Personal Injury or Death:**

Indicates a situation that can result in serious personal injury or death if not properly avoided.

**▲ WARNING**

**WARNING, Risk of Personal Injury or Death:**

Indicates a situation that can result in moderate personal injury or death if not properly avoided.

**▲ CAUTION**

**WARNING, Risk of Personal Injury:**

Indicates a situation that can result in minor personal injury if not properly avoided.

**NOTICE**

**WARNING, Risk of Property Damage:**

Indicates a situation that can result in minor to major property damage if not properly avoided.

### Product liability

- Disregarding the following instructions may result in malfunction, damage to property and personal injury and releases the manufacturer from product liability.

### Safety regulations

- National safety regulations must be observed!

---

## 1.2 Intended use

The Process Meters of the prodis® series are optimized for the sensor signals of the ASM sensors. Data can be transferred to the PC via the RS-232 interface. The optionally available relay outputs enable the monitoring of limit values and the control of machine processes. Use the unit as intended by operating within its specified technical data and ambient conditions.

The installation and operating instructions supplied with the unit must be observed. The data sheet of the respective Process Meter is part of this instruction manual. If not yet available, it may be requested by stating the respective model name.

## 2 Transport and storage

Observe storage and transport temperatures according to the operating temperature (see data sheet).

Max. rel. humidity 80%, condensation must be excluded.

The device must be secured against slipping and tipping during transport.

### Shipment damages

Check the device immediately for shipment damages. In case of any damage or equipment not operating appropriately, please contact the producer.

### Shipment content

- Process meter
- Operation instructions

## 3 Installation and initial operation

### 3.1 Mechanical installation

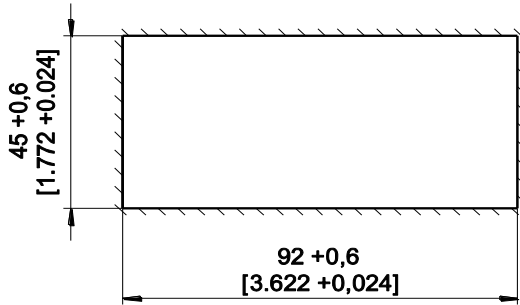

Cutout according to DIN 43700  
Maximum material thickness: 5 mm [.197]



1. Push the device into the front panel cutout as far as it will go.

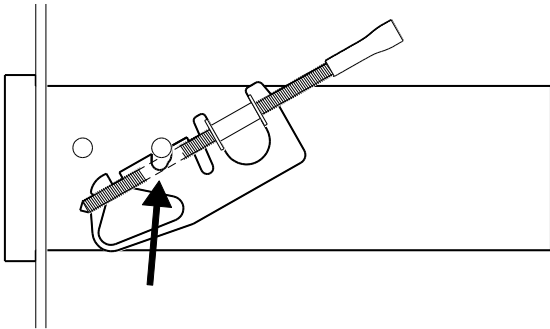

2. Hook the mounting clamp to the rear notch.

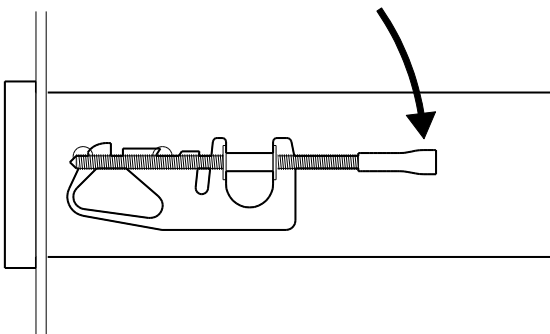

3. Push down the end of the mounting clamp until the front notch is locked.

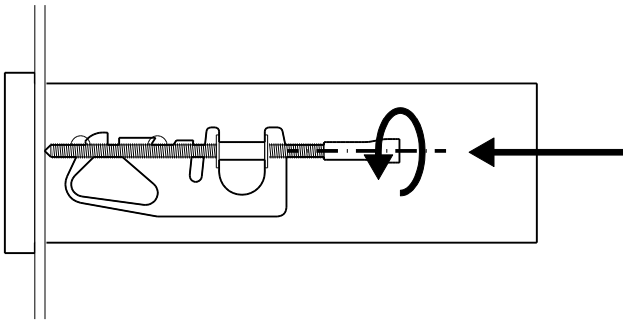

4. Turn the set screw with a blade screwdriver to the stop on the front plate.

## 3.2 Electrical connection

### NOTICE

**Damage to or destruction of the process meter due to excessive operating voltage or mounting errors**

- The meter must be operated only within values specified in the data sheet.
- Connection to power supply must be performed in accordance with safety instructions for electrical facilities and performed only by trained staff.
- It has to be guaranteed that the excitation voltage agrees with the indicated value on the type label.
- Do not open the process meter.

### Description and specifications

prodis®-INC is designed for use with incremental position sensors to display angles and displacements. The fast counter processes 90° phase shifted A, B signals (quadrature signals) for direction and counting information. Sensor excitation is supplied from the meter. With four membrane keys all parameters can be programmed for the special application. A zero signal and a reference signal can be used for calibration of the measurement system. Optional comparator functions with 4 NPN open-collector outputs are available, additional 2 of them have relay output.

## Specifications

<b>Display</b>	6-digit, 7-segment LED, height 14 mm, decimal point programmable
<b>Counting frequency</b>	250 kHz max., 1 MHz edge frequency
<b>Excitation voltage/current</b>	24 V DC $\pm 10\%$ /150 mA, residual ripple 1% <sub>SS</sub> ; 85-250 V AC, 50-60 Hz/180 mA max.
<b>Sensor excitation</b>	24 V DC/300 mA or 5V DC/500 mA
<b>Inputs</b>	A, B, Z, T (reference signal)
<b>Comparator outputs (option)</b>	Relais: 250 V AC/5 A, 30 V DC/5 A NPN: 24 V max./50 mA to GND
<b>Connection</b>	Terminal strip 12 pole, excitation 3 pole
<b>Temperature coefficient</b>	$\pm 20 \times 10^{-6} / ^\circ\text{C}$
<b>Operating temperature</b>	-10...+40°C
<b>Storage temperature</b>	-20...+85°C
<b>Weight</b>	24 V DC: approx. 250 g; 230 V AC: approx. 400 g
<b>Protection class</b>	Front IP60, rear IP40
<b>Humidity</b>	Max. 80% R.H., non condensing
<b>Safety of equipment</b>	Directive 2014/35/EU: EN 61010-1:2010
<b>EMC</b>	Directive 2014/30/EU: EN 61326-1:2013

## Programmable parameters / value range

<b>Value range display, offset, limit values</b>	-999999 to +999999
<b>Divisor, Multiplier</b>	0 to 999999
<b>Other programmable parameters</b>	Counting direction, decimal point position, last-value memory, Z signal evaluation, display brightness
<b>Signal T</b>	Manual zero, key lock, display value hold, Z release, relative measurement activation

## Interface RS-232

<b>Level</b>	RS-232: $\pm 8$ V, galvanically isolated
<b>Data format</b>	1 start bit, 8 data bits, 1 stop bit, no parity
<b>Transmission rate</b>	4800 / 9600 / ... / 115200 Baud



## Description

The process meter prodis®-INC is designed for use with incremental -position sensors to display angles and displacements. The fast counter processes 90° phase shifted A,B signals (quadrature signals) for direction and counting information. When using ASM sensors resolutions up to 5 µm resp. 2 angular minutes are possible. The sensor excitation voltage is supplied from the meter.

With four membrane keys all parameters can be programmed for the -special application. An index pulse and a reference switch can be used for calibration of the measurement system. Optional comparator function with two relays and four NPN open-collector outputs are available. With the RS-232 interface data can be transmitted easily to a PC, printer or PLC.

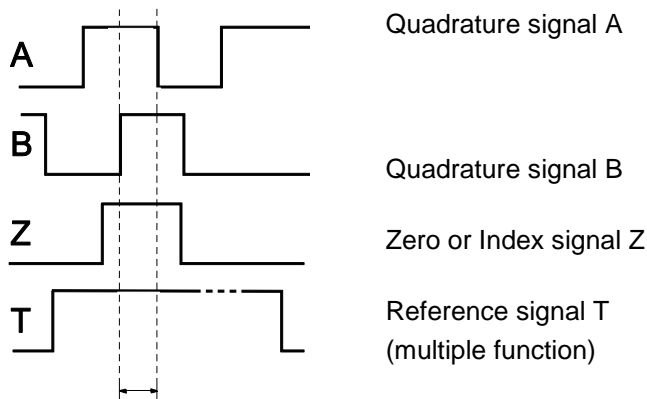

The reset of the display takes place for the condition (A & B & Z) resp. (A & B & Z & T).

The **Zero signal** is a pulse signal unique within the measurement range and explicit to the phase of the quadrature signal to reset the prodis®-INC meter.

The **Index signal** is a multiple periodical pulse signal within the measurement range and explicit to the phase of the quadrature signal, e.g. the zero signal of an incremental encoder that appears at every single turn.

The **Reference signal** is a pulse signal unique within the measurement range to enable the reset of the prodis®-INC meter, e.g. mechanical -reference contact for end position recognition.

**Wiring basic unit without comparator output**

Signals	Connector X1 Pin no.	Connector X2 Pin no.
Sensor excitation +U <sub>B</sub>	1	
Sensor excitation 0 V (GND)	2	
Signal A	4	
Signal $\bar{A}$	5	
Signal B	6	
Signal $\bar{B}$	7	
Signal Z (zero signal)	8	
Signal $\bar{Z}$ (zero signal)	9	
Signal T (reference signal)	10	
Signal $\bar{T}$ (reference signal)	11	
GND	12	
PD-INC-24VDC		
Excitation +24 V		13
Excitation 0 V (GND)		14
PD-INC-230VAC		
Excitation		13, 15
Protective ground		14

Signals	D-Sub pin no.
TxD	2
RxD	3
GND	5

**Rear view without comparator output**

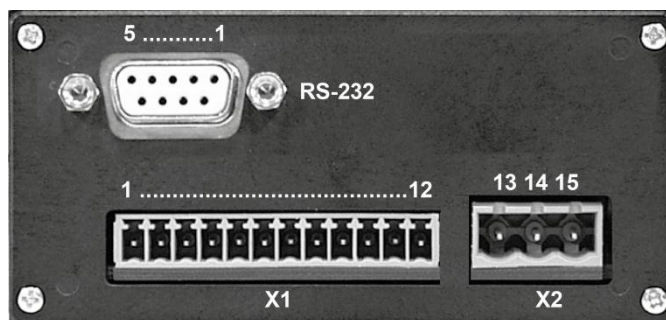

**Wiring basic unit with comparator output**

Signals	Connector X1 Pin no.	Connector X2 Pin no.
Sensor excitation +U <sub>B</sub>	1	
Sensor excitation 0 V (GND)	2	
Signal A	4	
Signal $\bar{A}$	5	
Signal B	6	
Signal $\bar{B}$	7	
Signal Z (zero signal)	8	
Signal $\bar{Z}$ (zero signal)	9	
Signal T (reference signal)	10	
Signal $\bar{T}$ (reference signal)	11	
GND	12	
PD-ADC-24VDC Excitation +24 V Excitation 0 V (GND)		13 14
PD-ADC-230VAC Excitation +24 V Protective ground		13, 15 14

Signals	Connector X3 Pin no.
TxD	17
RxD	16
GND	18

**Rear view with comparator output (option „REL2“)**

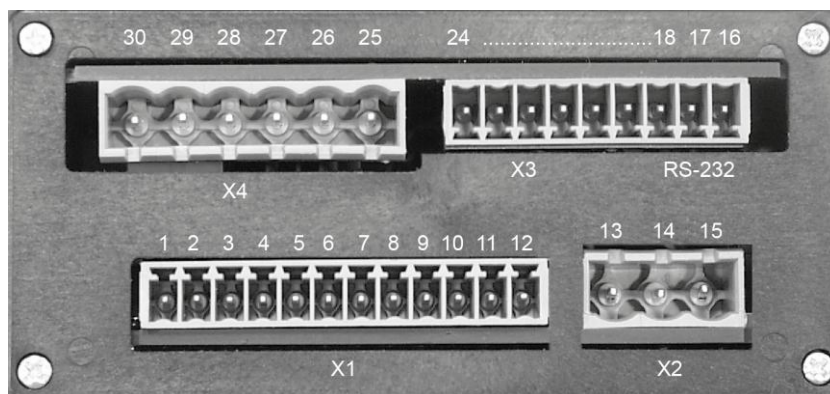

**Comparator function (option)**

Comparator	Comparator output				
	NPN collector	Connector X3 Pin no.	Relay	Connector X4 Pin no.	LED
Comparator 1	NPN1	20	Relay 1 NO NC Common	25 27 26	LED1
Comparator 2	NPN2	21	Relay 2 NO NC Common	28 30 29	LED2
Comparator 3	NPN3	22			
Comparator 4	NPN4	23			
	NPN GND	24			
	NPN U <sub>8</sub> (+24V)	19			

**Desktop version (option „DT”)**

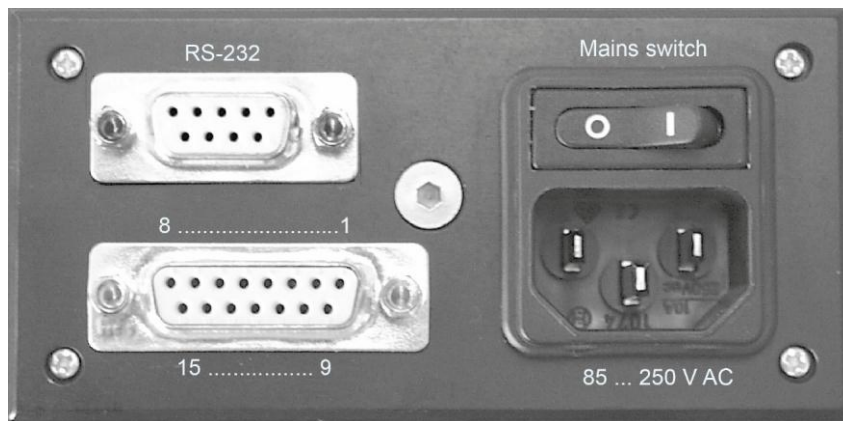

Wiring of connector X1 see table “Wiring basic unit”.

Comparator outputs (diagram)

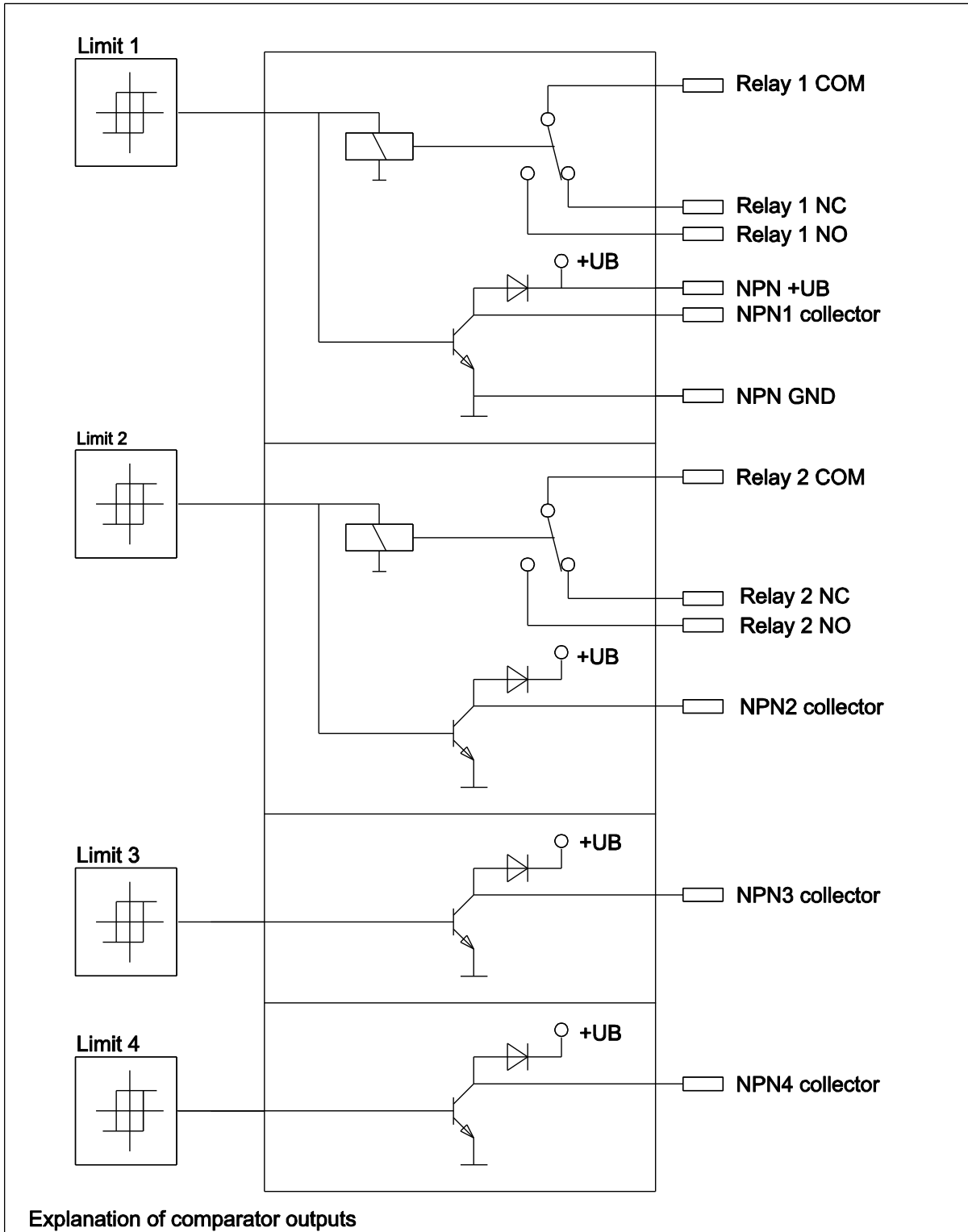

---

## RS-232 Interface

### Transmission of a position value

Send to prodis®: "r"  
Response of prodis®: CR, sign, n5, n4, n3, n2, n1, n0  
with ni: ASCII characters, leading digits  
filled with "0"  
Sign: positive sign = Space " "

### Tare function On/Off

Send to prodis®: "n"  
prodis® function: Tare function on/off

### Data format

1 start bit, 8 data bits, 1 stop bit, no parity  
Baud rate: programmable

### Net transmission rate

Max. 50/s approx.

## Examples of signal wiring

**Wiring single ended**    POSIMAG HTL  
or  
WS-X-PP530  
WS-X-PP24V

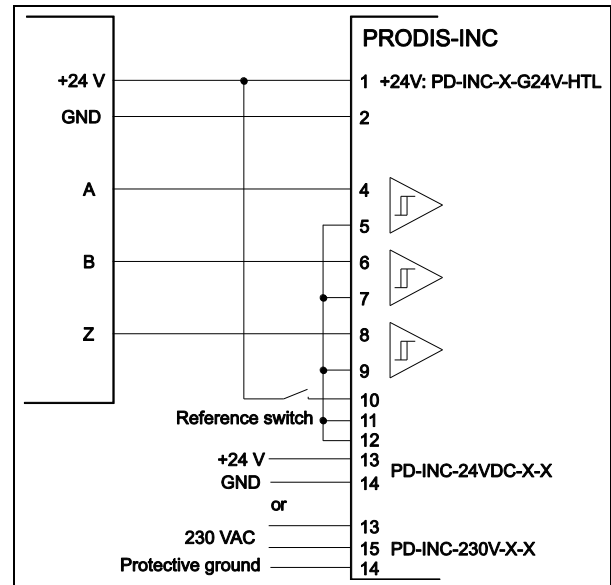

**Wiring differential**    POSIMAG  
TTL/HTL  
Sensor with  
Line driver 5V  
differential or  
RS485, reference  
switch

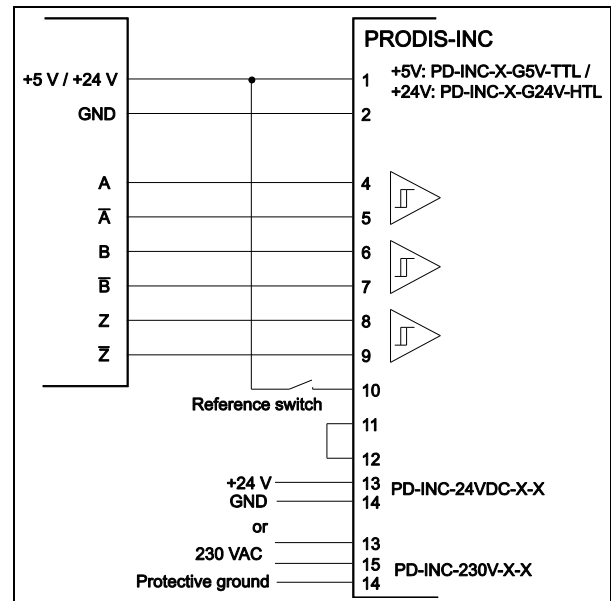





## 3.3 Startup

When the meter is switched on a short self-test sequence will start with all LED segments on and then the version of the process meter will be displayed. After that procedure prodis®-INC is in the normal mode.





## 4 Operation

### Operation keys and display



-  Key to control the programming menus
-  Multifunction key to reset the display and to store the parameters in a non-volatile memory
-  Multifunction key for parameter settings
-  Multifunction key for parameter settings











#### NOTICE

 +  means: hold the key  and press 

### Explanation and operation of the functions











#### Parameter settings

The parameter settings are effected in a programming menu.

Key / key combination	Function
 + 	Activate programming mode
 , 	Change the parameter by decimal steps
 + 	Reset activated parameter
 + 	Change the sign of signed parameters
	Store in non-volatile memory
	Proceed and return to normal mode
	New settings become effective immediately



### Operation of the functions – chart

Submenus	Parameter	Display	Value range	Factory setting
 + 	Decimal point	<i>dp</i>	1 bis 5, OFF	OFF
	Z signal active/inactive	<i>rEF</i>	1 / 0	0
	Reset button active/inactive	<i>nu l</i>	1 / 0	1
	Automatic relative measurement reset	<i>CHnu l</i>	1 / 0	1
	Multiplier	<i>ZAEHLE</i>	0 ... +999999	000001
	Divisor	<i>nEnnEr</i>	0 ... +999999	000001
	Counting direction	<i>drEh L/r</i>	left / right	L
	T signal	<i>t</i>	oFF/CS/CF/Hn/AF/tl/ brEF/Ctr3/Ctr4	oFF
	Last value memory	<i>lSt</i>	1 / 0	0
	Display brightness	<i>db</i>	1 ... 15	15
	Transmission rate	<i>bA</i>	4.8, 9.6 ... 115.2	9.6
 	Relative measurement mode	<i>Flashing decimal point</i>		0
	Reset			
	Offset	<i>oFFSEt</i>	-999999 ... +999999	000000
 + 	Limit value	<i>rELx</i>	+/- 999.999	+999.999
	Hysteresis	<i>Hμ rELx</i>	+/- 999.999	1
	Operating direction	<i>rx</i>	oEF, SCH	SCH
	Measurement mode	<i>rx</i>	HAU / CHA	HAU
 +  + power on*	Reset to factory default value	000000 for 2 s		

\* Disconnect device from excitation, wait 5 seconds, press both arrow keys together and hold. Connect excitation, the display shows "000000", then release both arrow keys.

### Normal mode, displaying the position value

The displayed measurement value will be calculated as

$$\text{Reading} = \frac{\text{Measurement value} \cdot \text{Multiplier}}{\text{Divisor}} + \text{Offset value}$$

Multiplier, divisor, decimal divisor and offset are user definable parameters (for calculation examples see appendix). When the display range is exceeded, the display shows *oFrAnGE*. PRODIS®-INC counts every pulse edge of the quadrature signal (times 4 counting mode).

### Relative measurement

In addition to the normal mode display PRODIS®-INC can display a second position value, a relative measurement mode with an independent zero to be set by the reset key manually. The normal mode measurement value remains in the background and will be displayed again after returning to the normal mode.

With the parameter CHnul (-> CHnul=1) the display will be set to zero when relative measurement is activated.

### Offset function

The offset function allows setting and changing of the offset value directly in the normal mode.

### Comparator function

(for versions with comparator function only)

Up to four comparator functions can be defined by programming of limit -value, hysteresis and operating direction. Outputs are two isolated relays with C/O contacts and four ground related NPN open-collector outputs. The operating condition of the comparators will be indicated by LED1 for -relay1, NPN1, NPN3 and LED2 for relay2, NPN2, NPN4. With the parameter measurement mode (rx) the comparator function will be assigned to the normal measurement or to relative measurement.

### Last-value memory

When the last-value memory function is activated by **ISt=1** (see table page xx) the current measurement value will be stored into memory when PRODIS®-INC is switched off. In the switched off condition, input pulses are not recognized. When the display is switched on again, the stored -measurement value will be displayed.

### T signal, functions

- oFF*: The T signal has no effect.  
*CS*: The T signal activates the relative measurement mode.  
*CF*: No function.  
*Hn*: The T signal resets the display in normal and relative measurement mode.  
*AF*: The T signal holds the current measurement value.  
The counting operation will not be interrupted.  
*tL*: The T signal locks the front key access (key lock)  
*brEF*: The T signal activates the signal "Z" reset function  
*Ctr3*: SEND The displayed value will be sent via the RS-232 interface  
*Ctr4*: SEND-CYC The displayed value will be sent periodically every 10 ms via RS-232

### Determination of the scaling parameters

- Determine the resolution of the position sensor 'dX' (displacement per counting edge) and calculate it to the unit to be displayed
- Define the resolution of the meter 'dA' (same unit as dx)
- Multiplier' = dX, Divisor' = dA
- Insert and transform multiplier and divisor by extension or reduction
- Set decimal point
- With the decimal divisor an additional shift right can be made.

As an alternative to the resolution parameters dX and dA the scaling parameters can be calculated by the measurement range parameters DX (display value for end of range) and DA (counting pulses for end of range).

### Calculating examples for the scaling

#### 1a. Meter for cable actuated position sensor model WS10 – 1000 – 25 – PP530

Least significant Digit (LSD) of the display has to be equivalent to 0.1 mm

The resolution with times 4 counting mode is  $25 \cdot 4 = 100$  pulse edges

Resolution of the position sensor: 100 pulse edges per mm:  $dX = 0.01 \text{ mm}$

Resolution of the meter:  $dA = 0.1 \text{ mm}$

$\text{Multiplier}' = dX = 0.01$

$\text{Divisor}' = dA = 0.1$

Insert the values and extend / reduce:

$\text{Multiplier} = 1$

$\text{Divisor} = 10$

Set decimal point between the first and the second digit from the right-hand side

### 1b. Alternative calculation of example 1a

The display value for end of range has to be 10000

Display value for end of range  $DX=10000$

Counting pulses for end of range

$DA=1000 \text{ mm} \cdot (25 \cdot 4) \text{ pulses/mm}$

Insert the values and extend / reduce:

$Multiplier = 1$

$Divisor = 10$

### 2. Meter for posimag® position sensor PMIS2 – 10 – 5 – PP530

LSD of the display has to be equivalent to 0.01 in

Resolution of the position sensor:  $dX = 5 \mu\text{m} = 0.005 \text{ mm} = 0.005/25.4 \text{ in}$

Resolution of the meter:  $dA = 0.01 \text{ inch}$

$$Multiplier' = dX = \frac{0.005}{25.4}$$

$Divisor' = dA = 0.01$

Insert the values and extend / reduce:

$Multiplier = 5$

$Divisor = 254$

Set decimal point between the second and the third digit from the right-hand side

### 3. Meter for incremental encoder with 2500 pulses per revolution

LSD of the display has to be equivalent to 0.1 degrees

Resolution of the sensor with times 4 counting mode:  $dX = 4 \cdot 2500 \text{ pulses / revolution}$  corresponding to  $360^\circ / 4 \cdot 2500 \text{ pulses}$

Resolution of the meter:  $dA = 0.1^\circ$

$$Multiplier' = dX = \frac{360}{2500 \cdot 4}$$

$Divisor' = dA = 0,1$

Insert the values and extend / reduce:

$Multiplier = 9$

$Divisor = 25$

Set decimal point between the first and the second digit from the right-hand side.

---

## 5 Maintenance and disposal

### 5.1 Maintenance and service

**NOTICE**

The prodis® process meters do not contain any components that can be repaired by the customer

- Do not open the housing.
- The prodis® process meter must not be modified.

#### Deinstallation

Disconnect electrical connections. Loosen fixing screws.

### 5.2 Disposal

Disposal of the device according to applicable government regulations.







perfect in sensors.

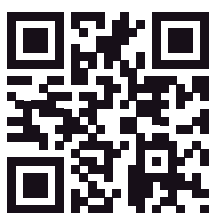

[www.asm-sensor.com](http://www.asm-sensor.com)

**ASM Automation Sensorik  
Messtechnik GmbH**  
Am Bleichbach 18 - 24  
85452 Moosinning  
**Germany**  
Tel. +49 8123 986-0  
Fax +49 8123 986-500  
[info@asm-sensor.com](mailto:info@asm-sensor.com)

**ASM Sensors, Inc.**  
650 W. Grand Ave., Unit 205  
Elmhurst, IL 60126  
**USA**  
Tel. +1 630 832-3202  
Fax +1 630 832-3204  
[info@asmsensors.com](mailto:info@asmsensors.com)

**ASM Sales Office UK**  
Tanyard House, High Street  
Measham, Derbs DE12 7HR  
**United Kingdom**  
Tel. +44 845 1222-123  
Fax +44 845 1222-124  
[info@asm-sensor.com](mailto:info@asm-sensor.com)